

INTERLINE

Free Standing Cabinets

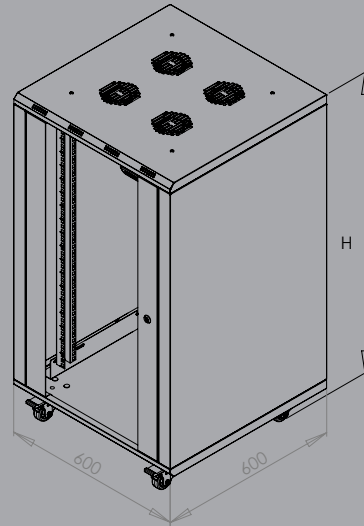

- The front and rear covers are openable, lockable and easily removable
- The rear cover is made by DKP sheet and the front side is made by 4 mm thick, impact resistant, tempered and smoked-colored glass which is supported by metal frames
- The main frame is 1 mm, mounting profiles are 1,5 mm
- Ventilation is provided by cooling units with 2 or 4 fans
- In 600x600 frame structure there are 12U, 16U, 20U, 26U height options.
- There are four 19" mounting profiles and these profiles can move deep within the cabinet.
- At the bottom part of the cabinets there is a brushed cable entry
- It has the option of using wheeled and fixed legs.
- Painted by impact-resistant, high strength, electrostatic Ral 9005 texture black color.



19" 600 x 600 INTERLINE Cabinet Genişlik - Width: 600 mm / Derinlik - Depth: 600 mm

Order No	U	h	H	KG
FORM INT-12U6060	12	536	700	29

U: Unit (1U=44,45mm) / h: İç Yükseklik - Inside Height (mm) / H: Tekerlek Dahil Dış Yükseklik - Outside Height (mm)